

1

2

3

4

5

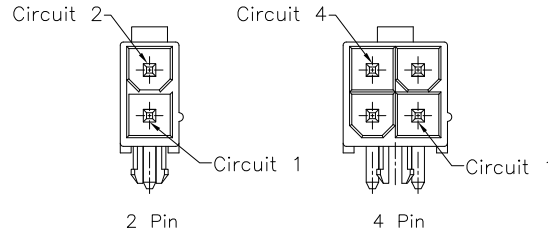
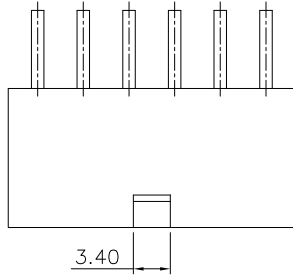

Specifications:

Current Rating:9.0A AC/DC
Voltage Rating:600V AC/DC
Contact Resistance:10m ohm. Max.
Insulation Resistance:1000M ohm. Min.
Withstanding Voltage:1500V AC For One Minute
Operating Temperature Range:-40°C To +105°C

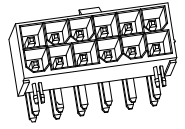

Materials:

Insulator:Nylon 66 (UL94V-0) \triangle
Insulator Color:White or Black \triangle
Terminal:Copper Alloy
Plating:Bright Tin/Gold Plated \triangle

How To Order:

420B2RXX20XX \triangle \triangle \triangle

Blank Natural \triangle
BK:Black \triangle
Blank Bright Tin Plated \triangle
1:Gold Plated
No. Of Contacts

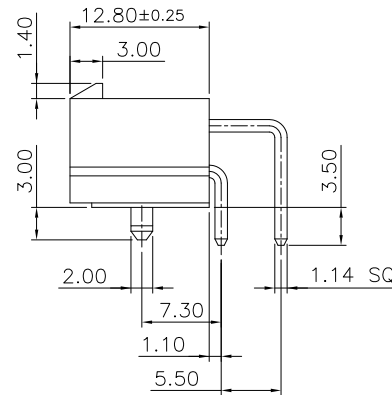
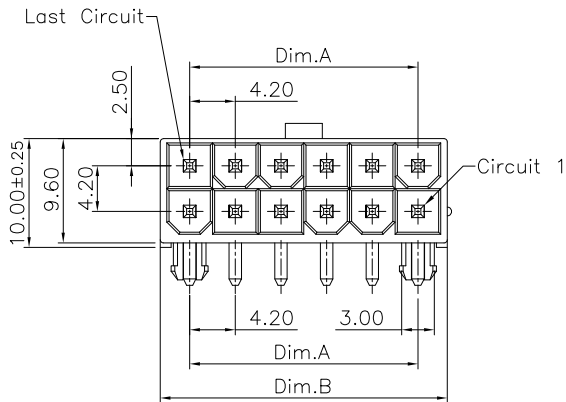

Dimension Information:

Circuits	Dim A	Dim B	Circuits	Dim A	Dim B
02	—	5.4	14	25.2	30.6
04	4.2	9.6	16	29.4	34.8
06	8.4	13.8	18	33.6	39.0
08	12.6	18.0	20	37.8	43.2
10	16.8	22.2	22	42.0	47.4
12	21.0	26.4	24	46.2	51.6

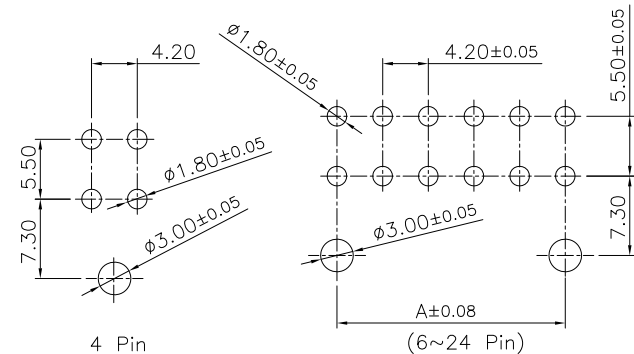
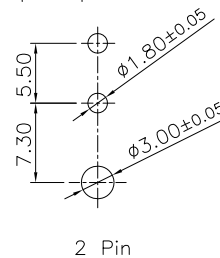

RECOMMENDED P.C.B LAYOUT

RoHS Compliant

DRAWN:

Andrew

GENERAL TOLERANCE:

.X=±0.40 \triangle
.XX=±0.30 \triangle



ON-SHORE TECHNOLOGY, INC.

F 27-DEC-2023 Add Plated Options Lucy Du

CHECKED:

Jeremy Liu

UNIT: MM

DESCRIPTION: 4.2mm Power Wafer Double Rows
R/A With Peg Type

SIZE

E 29-Jun-2020 ECO-TW200004 Romina Wu

D 25-Sep-2019 \triangle Jamie Wang

APPROVAL:

Mike Wu

SCALE: 1:1

PART NO:

420B2RXX20 \triangle \triangle \triangle

A 20-Oct-2010 Richie

REV DATE FILE BY

PROJECTION: \oplus

A

B

C

D

1

2

3

4

5

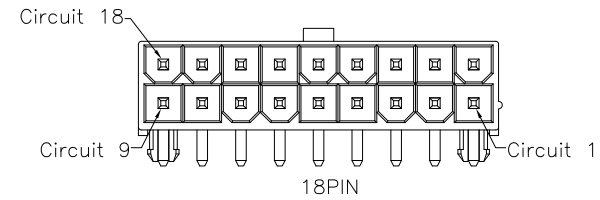
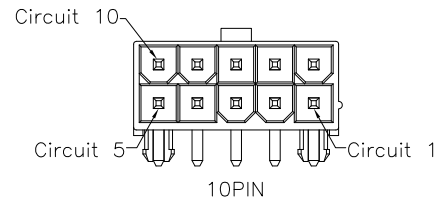
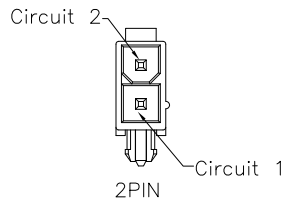
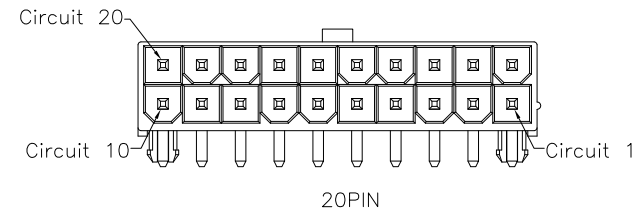
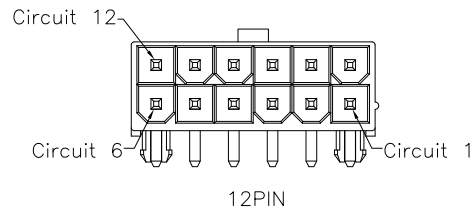
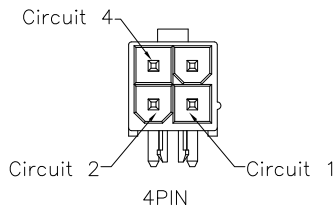
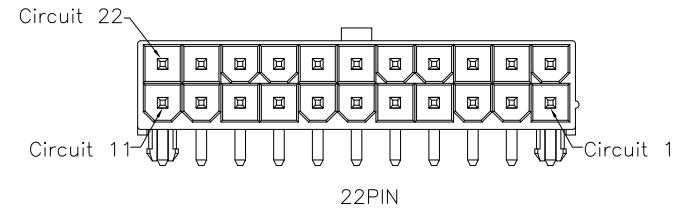
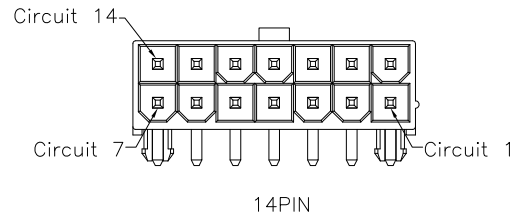
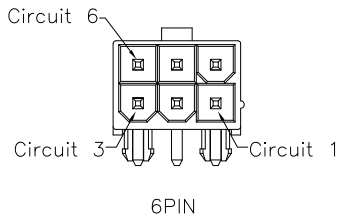
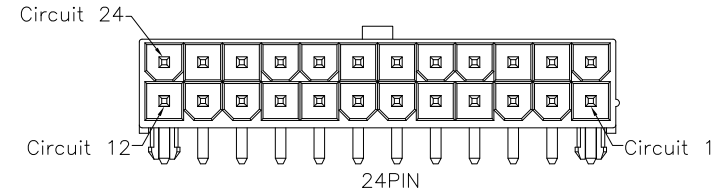
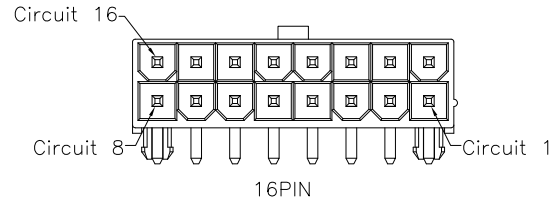
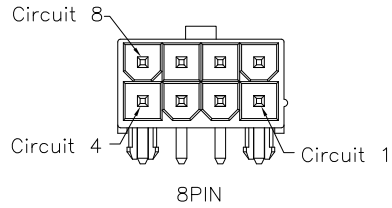

2~24P Protection Key Drawing(Ref.)

RoHS Compliant

				DRAWN: Andrew	GENERAL TOLERANCE: .X=±0.40 .XX=±0.30		ON-SHORE TECHNOLOGY, INC.	
G	27-DEC-2023	Add Plated Options	Lucy Du	CHECKED: Jeremy Liu	UNIT: MM			
F	30-DEC-2022	Add UL94V-2	Selin Lin	APPROVAL: Mike Wu	SCALE:1:1	PART NO:	420B2RXX20	
E	29-Jun-2020	ECO-TW200004	Romina Wu		SHEET: 2 / 2			
D	25-Sep-2019		Jamie Wang		PROJECTION:			
A	20-Oct-2010		Richie					
REV	DATE	FILE	BY					

A

B

C

D